

Product brochure

Rigofill® ST / Rigofill® ST-B

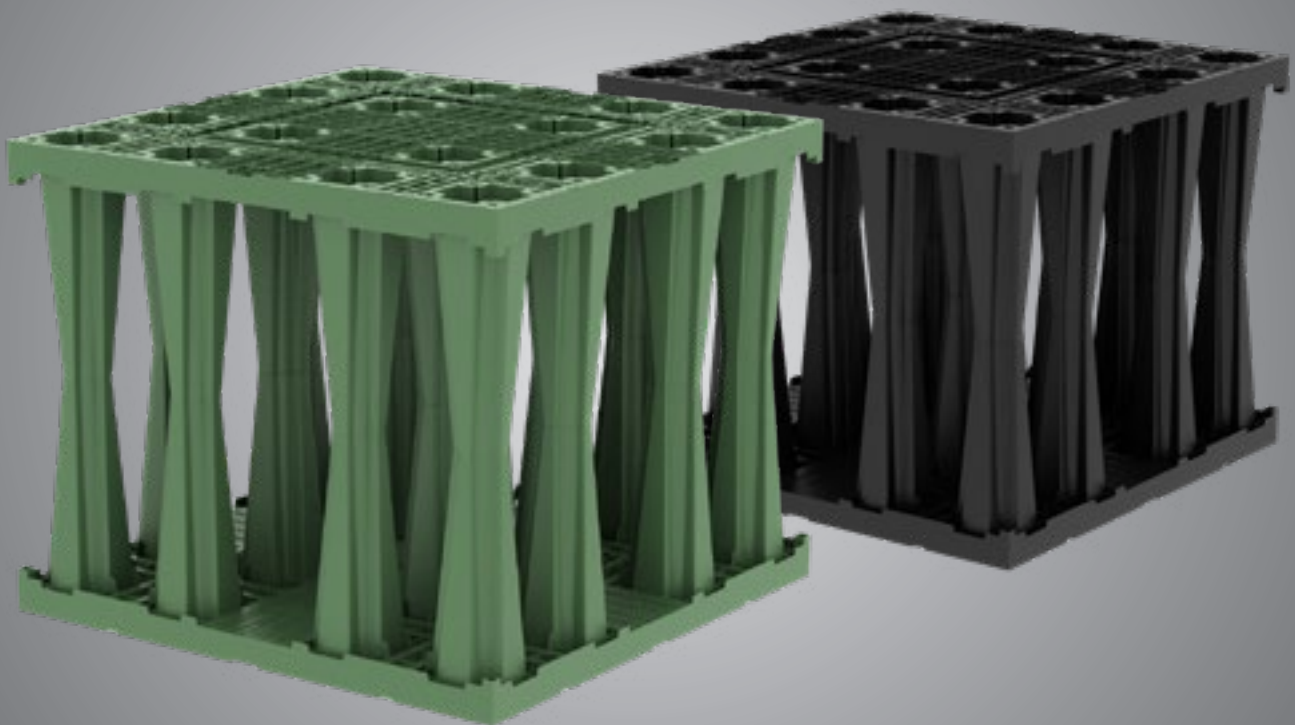

Underground storage/infiltration modules according to EN 17152-1

Rigofill® ST – system



Rigofill® ST – system

Rigofill® ST



Rigofill® ST-B



 SLW 60/HGV 60 

 SLW 30/HGV 30 



NB

In what follows, an illustrative explanation of the Rigofill system will be given by means of the green module. All properties and advantages also apply to the Rigofill ST-B system. The systems have been optimised for different installation situations.

 In the following, please be sure to pay attention to this sign.

Statements marked with this sign apply to both Rigofill ST and Rigofill ST-B.

Table of contents

Rigofill® ST / ST-B – complies with EN 17152-1	4
Storing stormwater with storage/infiltration systems	6
Applications	7
■ ■ Infiltration	7
■ ■ Retention	8
■ ■ Harvesting/fire water storage	9
■ ■ Increased strength for the storage/infiltration system	10
Product benefits	12
■ ■ Modular design	12
■ ■ System geometries	13
■ ■ Storage volume	14
■ ■ Installation	16
■ ■ Inspection	18
■ Loading – Rigofill ST	20
■ Loading – Rigofill ST-B	22
QuadroControl ST – system shaft	24
Design-relevant dimensions	26
■ ■ Rigofill ST	26
■ ■ QuadroControl ST	28
Rigofill ST product overview	30
Rigofill ST-B product overview	32
Our services	34
Contact and Service	35

General information on using our products and systems:

Information about or assessments of the use and installation of our products and systems is exclusively provided on the basis of the information submitted. We do not assume any liability for damage caused by incomplete information. If the actual situation deviates from the planned situation or if a new situation occurs or if different or new installation techniques are applied, these must be agreed upon with FRÄNKISCHE, since these situations or techniques may lead to different conclusions. Notwithstanding the above, the customer is solely responsible for verifying the suitability of our products and systems for the intended purpose. In addition, we do not assume any liability or responsibility for system characteristics and system functionalities when third-party products or accessories are used in combination with FRÄNKISCHE systems. We only assume liability if original FRÄNKISCHE products are used. For use in other countries than Germany, country-specific standards and regulations must also be observed.

All information provided in this publication is generally up to date at the time of printing. Moreover, this publication was prepared with the greatest possible care. However, we cannot rule out printing errors or translation mistakes. Furthermore, we reserve the right to change products, specifications and other information, or changes may be necessary due to legal, material or other technical requirements, which no longer could be considered for this publication. For this reason, we are unable to accept any liability if this is based solely on the information contained in this publication. Instrumental in connection with information about products or services are always the purchase order, the concrete product purchased and the related documentation or the information provided by our specialist staff in the specific case.

Rigofill® ST / ST-B – complies with EN 17152-1



EN 17152-1 is the first product standard for storage/infiltration modules on a European basis. It was published in November 2019 together with the test standards for short-term compressive strength (EN 17150) and long-term compressive strength (EN 17151).

This allows determining and comparing the long-term compressive strength based on a European standardised test method for the first time.

The standard will now gradually replace national approvals or be used as a basis for the test requirements of approvals.

The focus is on determining the long-term breaking load. This is determined from extensive tests lasting up to several 1000 h. Using statistical, standardised evaluation methods, long-term compressive strength is then determined for a service life of at least 50 years.

While EN 17152-1 only requires proof of the vertical long-term compressive strength when the storage/infiltration modules are used in infiltration systems, proof of the vertical and horizontal long-term compressive strength is required when they are used as a storage or temporary storage system.

Furthermore, there are detailed specifications for the material tests as well as the requirement of an EN-compliant marking of the modules, in which, depending on the application, long-term compressive strength is also required for the first time.





EN

EN 17152-1

Plastics piping systems for non-pressure underground conveyance and storage of non-potable water – Boxes used for infiltration, attenuation and storage systems

- Part 1: Specifications for storm water boxes made of PP and PVC-U

Storing stormwater with storage/infiltration systems



Basic element for underground water storage facilities

Rigofill ST are plastic tanks to be installed underground (storage/infiltration modules) in which water is collected and stored. Storage/infiltration systems temporarily collect stormwater and discharge it later. In addition to infiltration using underdrained swale systems, pipe swales, and gravel swales common in the past, increasingly more storage/infiltration systems are being built today.

The storage space of the storage/infiltration system consists of numerous Rigofill ST modules which can be combined three-dimensionally to form large systems.

The advantage of this method is that the void ratio is up to three times larger in these infiltration systems than in gravel swales which saves space and excavation work. Rigofill ST is a modular system which is characterised by high flexibility, rapid installation and a high level of user-friendliness.



Application – infiltration



Stormwater infiltration – giving back to nature

Large amounts of stormwater can reduce the performance of wastewater treatment systems. Infiltrating unpolluted stormwater nearby has therefore several advantages. A constant growth in built-up areas and an increase in impervious surfaces prevent natural infiltration of stormwater into the soil. Special infiltration systems are used in order to discharge it to the water cycle.

In addition to infiltration using pipe swales, increasingly more storage/infiltration systems are being built. The advantage of this method is that the storage volume of the infiltration system is increased, and space and excavation are saved as compared to gravel swales.

Stormwater is thus returned to the natural water cycle and can contribute to producing new groundwater. Infiltration systems are subject to very high requirements. Consequently, they have become an important component of urban drainage.

Storage/infiltration systems considerably increase the underground storage volume. High-performance storage/infiltration systems can be installed even in confined spaces. In particular in urban construction no additional space is required and precious building ground is saved.

Infiltration

- ① Rigofill ST storage/infiltration module
- ② RigoFlor geotextile
- ③ QuadroControl ST system shaft

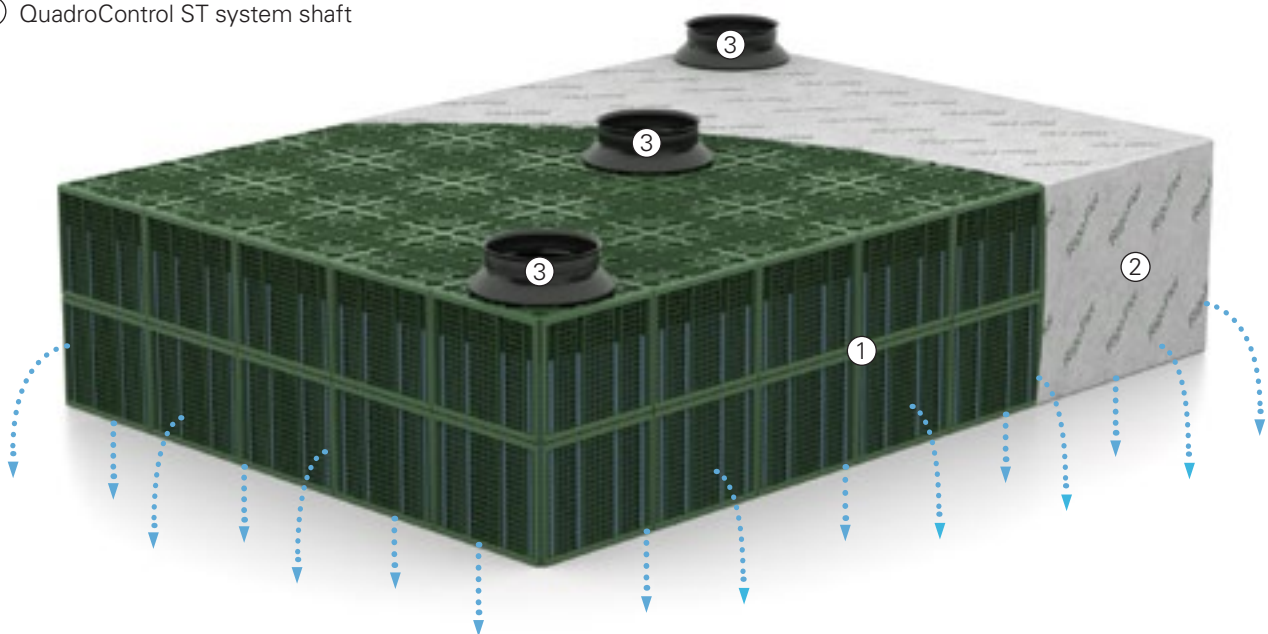

Application – retention



Retaining stormwater – instead of flooding

If subsoil conditions are unfavourable to infiltration, the goal is to retain the stormwater and ensure a retarded, time-lagged discharge. Exposure to impulsive stress can be eliminated or reduced in sewer networks, wastewater treatment systems and waterbodies.

Stormwater retention systems retard the infiltration of stormwater. They are comprised of a watertight retaining element, an inlet and a vortex outlet.

The stormwater distributes evenly in the system where it can be stored and is then discharged in a controlled manner through throttle shafts. If infiltration must be avoided or to prevent unintended discharge of groundwater or strata water (e.g., in case of contaminated soil), it is necessary to waterproof the retention system.

Stormwater runoff from impervious surfaces that cannot infiltrate naturally leads to peak loads in sewer systems.

Stormwater retention facilities collect stormwater in an underground storage tank and discharge it in a retarded manner but continuously. Their very short construction times make storage/infiltration systems an inexpensive alternative to conventional retention facilities such as retention channels or underground concrete tanks.

Retention

- ① Rigofill ST storage/infiltration module
- ② RigoFlor geotextile
- ③ Impermeable membrane (KDB)
- ④ QuadroControl ST system shaft
- ⑤ Adapter

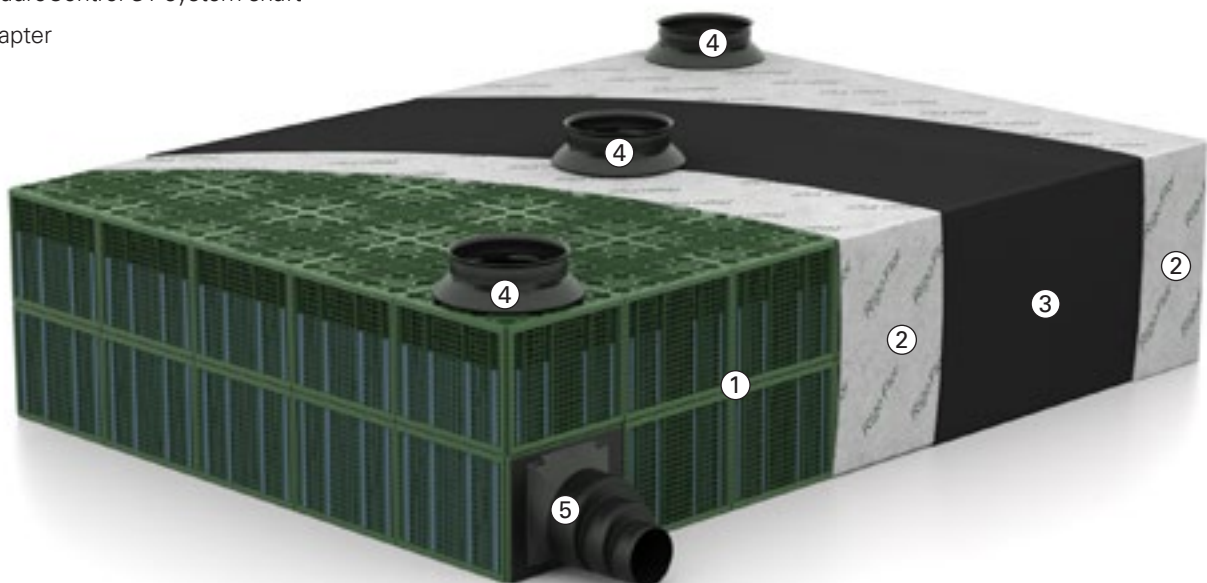

Application – harvesting/fire water storage



Harvesting stormwater – saving drinking water

Water – particularly drinking water – is a priceless resource which should be treated responsibly and used sparingly. It is therefore wise to collect, store and use stormwater if the water must not necessarily be suitable for drinking purposes, instead of allowing the water to infiltrate into the soil unused or diverting it into the sewer system.

There are many examples: irrigation for greens, car wash, use in toilets, etc. Water is diverted into a waterproof storage/infiltration system and can be supplied for use via a pumping system. The use of the Rigofill ST system allows for finding solutions that fit project-specific requirements – even under the most difficult conditions such as very tight space, narrow conditions, low cover, high groundwater level, etc.

Stormwater harvesting systems provide water for different domestic and industrial water uses. They comprise a watertight retaining element, an inlet with upstream stormwater treatment system, a pump shaft and a system control.

Using Rigofill ST for fire water storage also saves water, since system checks can be made in a filled state and water does not have to be pumped out as is the case with conventional concrete tanks.

Harvesting/fire water storage

- ① Rigofill ST storage/infiltration module
- ② RigoFlor geotextile
- ③ Impermeable membrane (KDB)
- ④ QuadroControl ST system shaft
- ⑤ Tapping shaft (on-site)

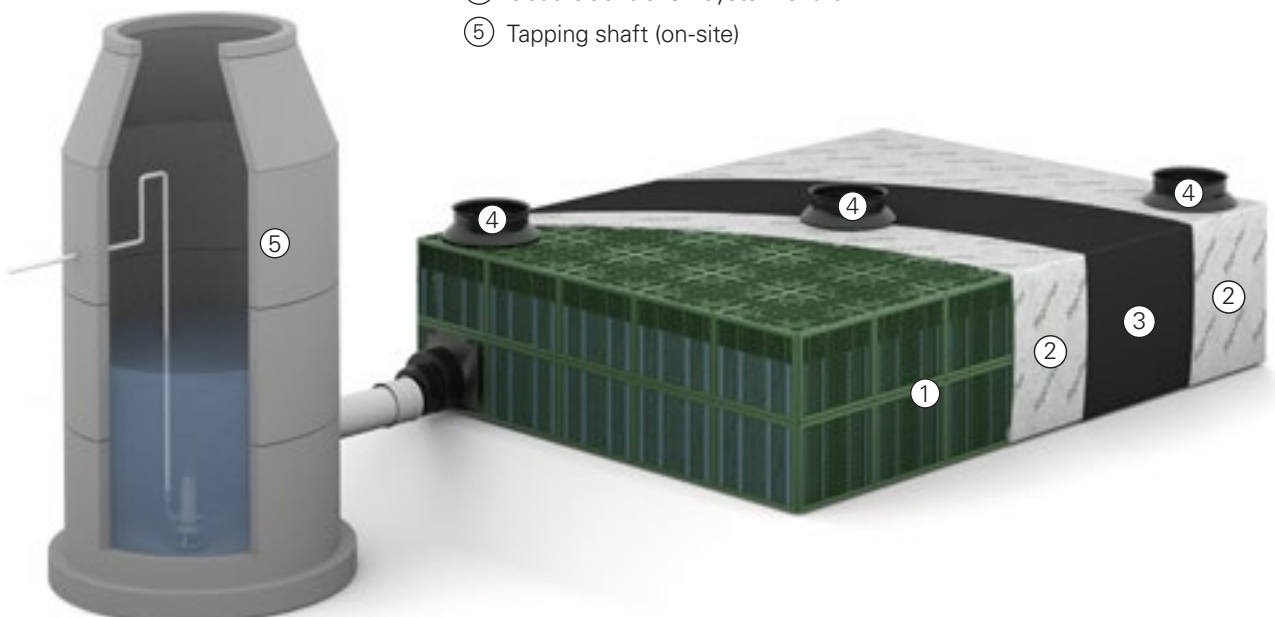

Increased strength for the storage/infiltration system



The supporting grid – for increased requirements

The supporting grid was designed to expand the range of applications for increased requirements, e.g., for cases of groundwater outside the system or multiple-layer systems with high installation depths. Installation situations like these lead to increased horizontal loads on the storage/infiltration system and installation limits being restricted significantly.

This led to the development of an additional supporting element for the Rigofill ST designs, i.e., the so-called supporting grid. The supporting grid features a honeycomb design and exactly matches the column structure of the two half elements. It is installed between two half base elements. The additional support increases the horizontal strength by approx. 60 %, thus allowing a significant expansion of the installation limits.

When you place an enquiry, we will check and determine whether or not the supporting grid is required. The verifiable static verification can be prepared by FRÄNKISCHE project-specifically and made available, if required.

NB

The supporting grid is available for any Rigofill ST design and will be supplied in the respective module colour. The supporting grid is illustrated here in grey for reasons of clarification only.

Retention

Harvesting/fire water storage

- ① Rigofill ST storage/infiltration module
- ② RigoFlor geotextile
- ③ Impermeable membrane (KDB)
- ④ QuadroControl ST system shaft
- ⑤ Supporting grid

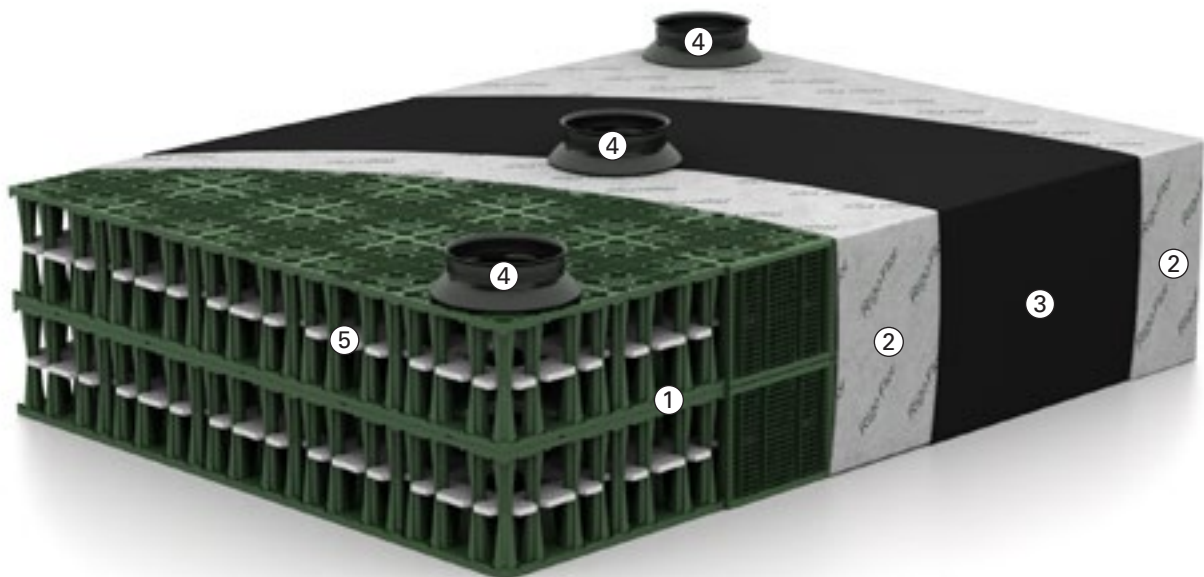



Installation in groundwater

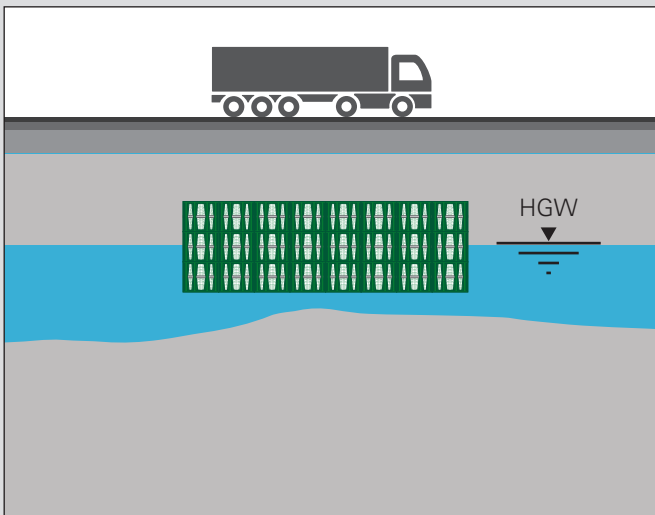

High installation depth of a multiple-layer storage/infiltration system

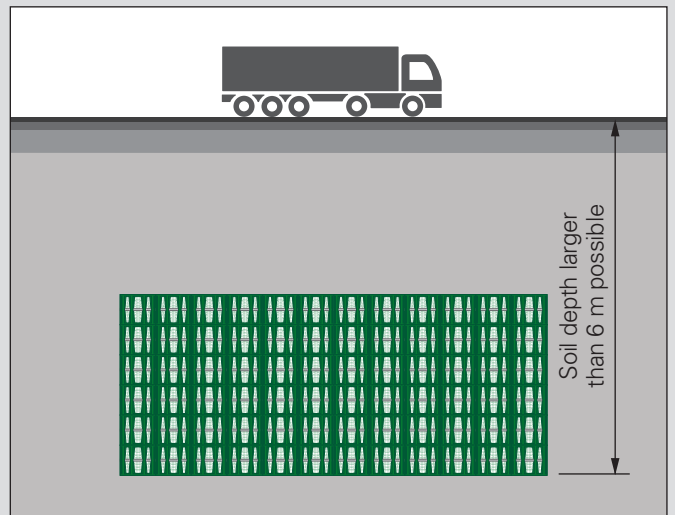

Structure of module with supporting grid



Rigofill ST with supporting grid

Structure of shaft with supporting grid



QuadroControl ST with supporting grid

Modular design



Individual system geometries due to modular design

The sizes (length and width) of Rigofill storage/infiltration systems can be freely designed with hardly any limitations. The square 800 mm block layout can be easily adapted to fit nearly any layout.

With heights of 660 mm (full block) and 350 mm (half block), systems can be built in various sizes to accommodate any single-layer or multiple-layer combination. Therefore, the system can be very easily adapted to on-site requirements. Under high groundwater levels or low permeability of the native soil, for example, rather shallow-depth systems are to be preferred. For soils with good permeability, however, high and compact systems are favourable and may be built accordingly. The maximum space available is used.



Possible system geometries

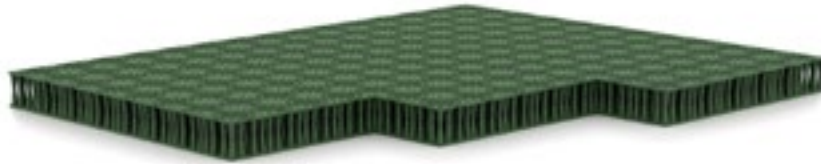

Rigofill ST **1-layer**

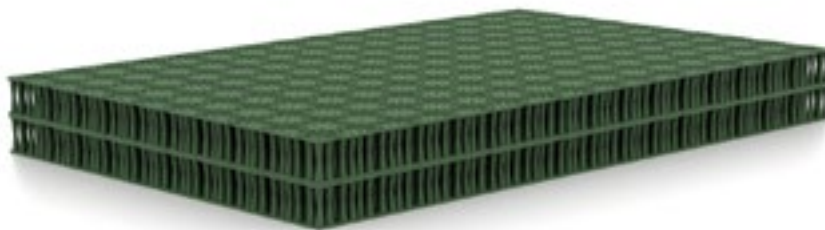

Rigofill ST **2-layer**

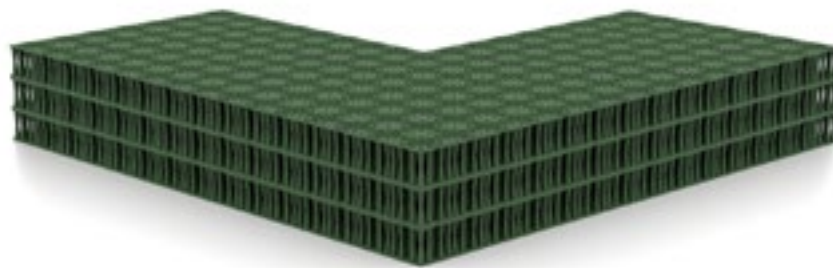

Rigofill ST **3-layer**

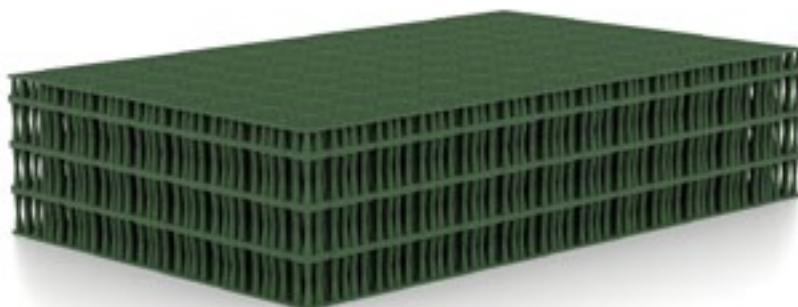

Rigofill ST **3 1/2-layer**

Storage volume



Extremely high volume

The Rigofill ST full block provides a storage volume of 406 litres with a gross volume of 422 litres. With a storage volume of more than 96 %, it stores three times as much water as gravel swales. The half block has a height of 350 mm and is used if shallow systems are required, e.g., in case of high groundwater levels. With a gross volume of 224 litres, it offers a storage volume of 212 litres.

Column void

The storage/infiltration module is 100 % available as storage space. Large openings at the column base and at the column connection allow unrestricted filling and emptying of the columns.



Storage/infiltration systems as compared to gravel swales

Pipe swales and gravel swales can only use approx. 30 % of their volume to store water. Therefore, three times the required water storage volume must be provided by excavation. This requires lots of space which is frequently not available in urban areas. Rigofill ST storage/infiltration systems save an enormous amount of space and excavation work. Thus, subsoil storage spaces for stormwater can be built in a very efficient and cost-saving way.

Storage/infiltration systems considerably increase the storage space. High-performance storage/infiltration systems can be installed even in confined spaces.



Designed & engineered in Germany



Future-proof system

Strong and durable storage/infiltration systems require technically reliable and ideally matched components. All Rigofill ST and Rigofill ST-B system components combine to a reliable system for stormwater storage which withstands any stress for decades. Repairs in case of damage are complicated and expensive in particular with large underground systems.

In the production of all system components, FRÄNKISCHE attaches greatest importance to using tried-and-tested materials.

Consistent quality control and the certification of stormwater management systems by independent testing institutes provide design engineers, investors, building companies and installers with utmost reliability.



Superior materials

Rigofill ST and Rigofill ST-B modules are made of polypropylene and are especially robust and durable. The modules and all system components are manufactured in Germany according to certified processes. Ideal storage and transport conditions furthermore guarantee that customers receive the kind of quality they expect when buying FRÄNKISCHE products.

Installation



Easy construction site handling



Requires little space for storage

The storage/infiltration modules are delivered in compact, stacked units with 17 modules per pallet. The easy stackability of the Rigofill ST and ST-B modules allows them to be stored even in confined construction space, even outside the excavation pit. This facilitates installation, since no additional storage space must be provided in the excavation pit. Installation is neither impeded nor constrained.



Pre-assembly

Depending on the requirements, Rigofill ST and Rigofill ST-B modules can be pre-assembled in no time at all, both outside and inside the excavation pit in just one easy step. Easy high tensile strength snap connections allow for combining two half elements to create a reliable unit in only a short period of time. This can be easily done by one person only without requiring any additional tools. The moveable parts of the snap connection are recessed and thus protected from damage.



Easy assembly

There is no need to adhere to any complex installation pattern – the pre-assembled modules or half blocks can just as well be connected to create a single unit. The low weight allows this to be done by one person only. Connectors establish firm connections between the individual modules. The surface can be accessed immediately without any risk of accidents, since the hole size of the columns is dimensioned respectively (< 100 mm). Thus, no additional covers of column holes are required.

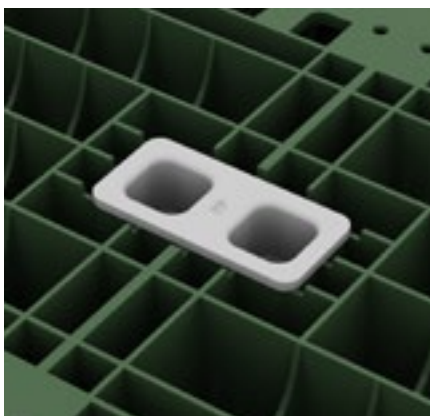

Single-layer connector

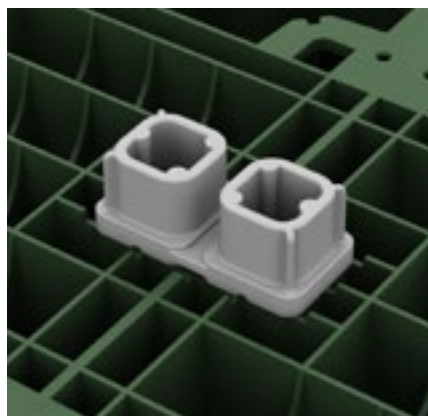

Multiple-layer connector

Connectors

Connectors help secure the modules in place. Secure modules using connectors on the top surface of the module in the centre of each edge that is adjacent to another module.



Easy construction site handling
(reduced machining time, up to 34 full blocks can be moved with one stroke)

Little space requirement
for on-site storage
(1.28 m² for 13.79 m³ storage volume)

Pallets can be stored in the excavation pit
→ **short distances** during installation of blocks

Installation in modular block type structure: Half-elements can be assembled to form full blocks at their final location in the modular block type structure.

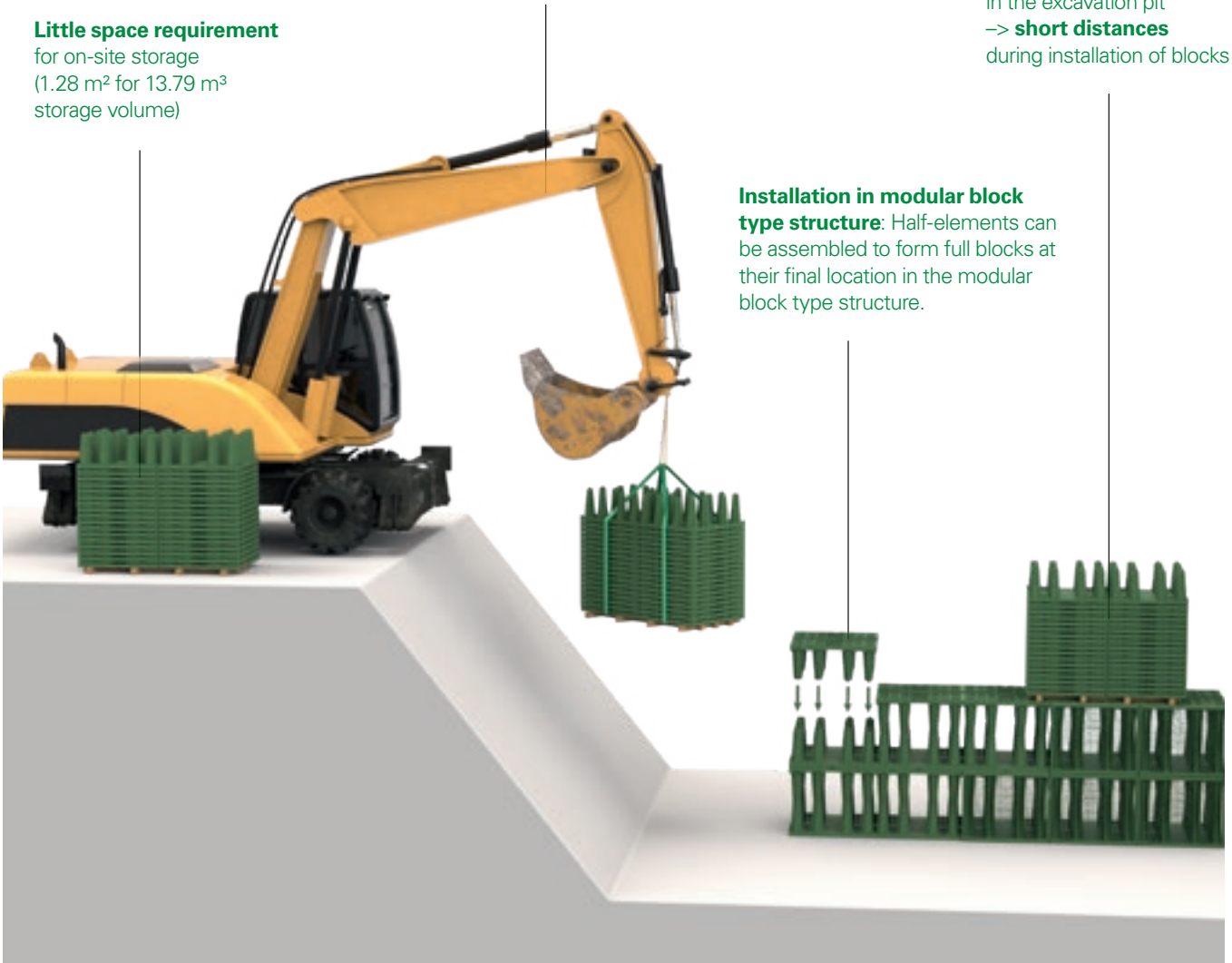

Inspection



CCTV inspection even when filled

Storage/infiltration systems are durable structures for urban drainage; they must work reliably for decades. Durability and reliability are essential requirements. The best way to inspect the state of a system using state-of-the-art technology is CCTV inspection. Thus, a storage/infiltration system can be checked excellently – for final acceptance or later. This establishes safety for authorities, engineers, construction companies, customers, and operators.

Cross-shaped inspection tunnel

Rigofill ST modules have a cross-shaped tunnel which makes the storage/infiltration system camera-accessible and flushable in two axes and thus in four dimensions.

The special and open design of the inspection tunnel allows for an unobstructed view of the entire interior and not only the inspection tunnel.

For example, the load-bearing elements, the condition of the geotextile and the entire soil area can be visualised. Rigofill ST and Rigofill ST-B provide excellent possibilities for inspecting the interior of the system at any time.

The ideal, level and vibration-free running surface and the slim column structure allow for an unobstructed view of the entire module volume. The QuadroControl ST shaft for Rigofill ST, which can be integrated, allows for easy access of the automotive dolly for both professional final acceptance inspection and flushing technology.



100%
inspectable

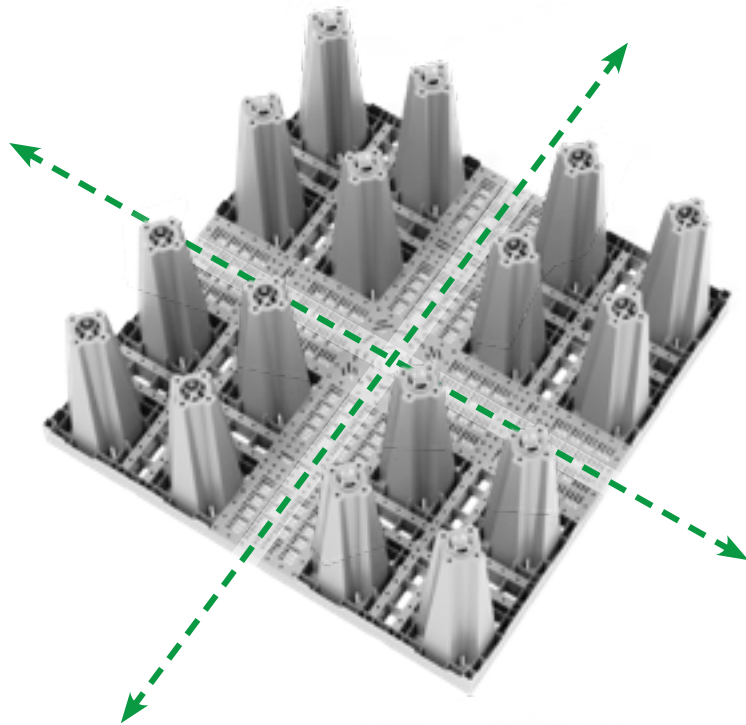



Recommended camera equipment



A standard sewer camera is sufficient for camera inspection. A rotatable and height-adjustable camera head allows for an optimal view of the lateral soil area, a controllable carriage ensures a centred positioning, and high-performance optics together with lighting allow for a perfect picture.

Certified CCTV accessibility



Rigofill ST has been designed for the use of modern CCTV inspection technology. The inspectability of the Rigofill ST and QuadroControl ST system unit has been tested and confirmed by leading manufacturers of pipe CCTV inspection technology!

Recommended: tender invitation for final acceptance inspection



Final acceptance of sewers using camera inspection has long since become a matter of course in sewer construction. The final acceptance inspection is also important in the construction of storage/infiltration systems! Planning engineers should absolutely include this in their tender documents. For instructions on the professional system configuration of the CCTV inspection technology, please refer to www.fraenkische.com.

Tender texts  www.fraenkische.com

Loading – Rigofill® ST

Rigofill® ST

SLW 60/HGV 60

Storage/infiltration systems are subsoil structures and must have sufficient load-carrying capacity against impacting soil and traffic loads. Rigofill ST storage/infiltration systems are extremely robust and have been designed for traffic loads up to SLW 60/HGV 60. FRÄNKISCHE storage/infiltration systems have been designed for a minimum lifetime of 50 years.

Installation under traffic areas

When installed under traffic areas, relevant national guidelines, e.g., RStO 12, must be observed. To build the planum for the road construction, an upper levelling layer must be provided. It should preferably be built as a gravel sub-base with a thickness of at least 350 mm, other materials usually result in larger covers. Generally, a uniform modulus of deformation $E_{v2} \geq 45 \text{ MN/m}^2$ must be proven on the planum.



Standard installation under a traffic area

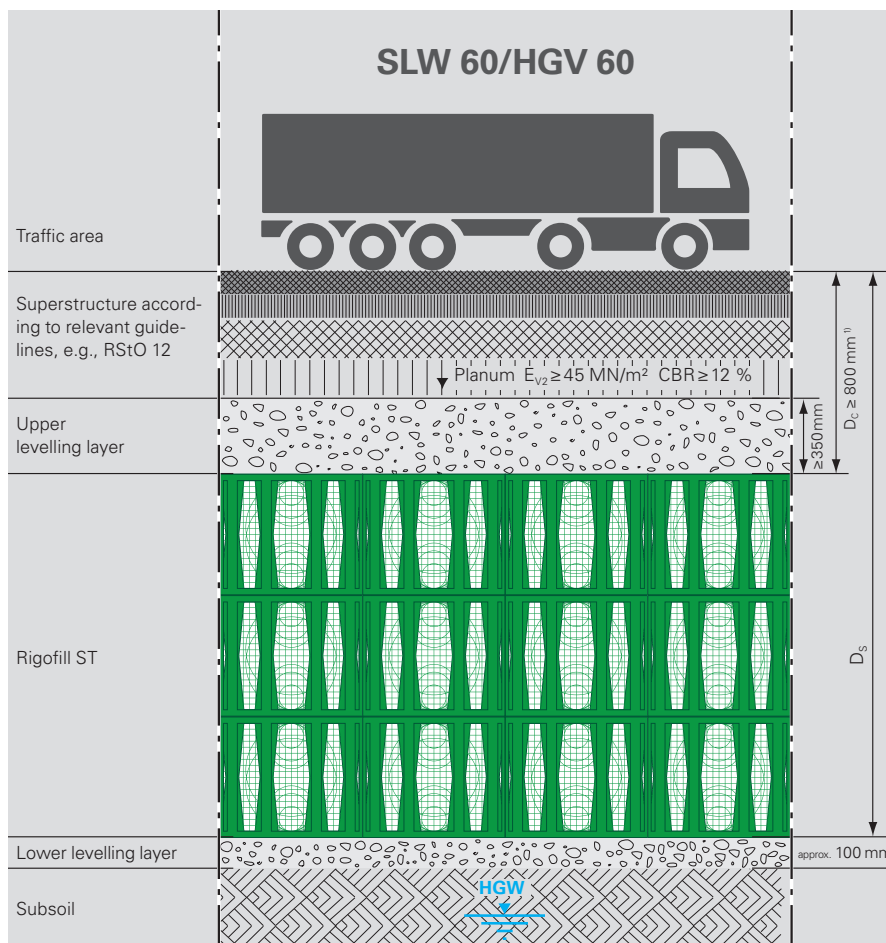

¹⁾ Lower cover on request

Rigofill® ST

The subsoil structures must have sufficient load-carrying capacity against impacting soil and traffic loads to ensure reliable stability. This is why Rigofill ST is suitable for traffic loads of up to **SLW 60/HGV 60**. With conventional installation parameters*, depths of cover of D_c 4 m and soil depths of D_s 6 m are possible for infiltration systems.

A project-specific stability analysis can be prepared by FRÄNKISCHE.

* HGV 60, specific weight of soil 18 kN/m^3
mean soil temperature max. $23 \text{ }^\circ\text{C}$,
soil depth 6 m, $\kappa = 0.3$, 4-layer

NB

for HGW over structure soil

Rigofill ST systems, which are used as watertight storage systems with impermeable plastic membrane, have been designed for application above the highest groundwater level (HGW).

High installation depths and use in groundwater are possible under corresponding technical conditions after consultation with FRÄNKISCHE. (See pages 10–11)

Please contact us!

Example – Rigofill® ST



Rigofill® ST

SLW 60/HGV 60



Loading – Rigofill® ST-B

Rigofill® ST-B

SLW 30/HGV 30

Storage/infiltration systems are subsoil structures and must have sufficient load-carrying capacity against impacting soil and traffic loads. The special material composition of Rigofill ST-B makes it ideal for surfaces with less traffic such as sports fields or green spaces. FRÄNKISCHE storage/infiltration systems have been designed for a minimum lifetime of 50 years.

Installation under traffic areas

When installed under traffic areas, the relevant guidelines, e.g., RStO 12, must be observed. To build the planum for the road construction, an upper levelling layer must be provided. It should preferably be built as a gravel sub-base with a thickness of at least 350 mm, other materials usually result in larger covers. Generally, a uniform modulus of deformation $E_{v2} \geq 45 \text{ MN/m}^2$ must be proven on the planum.



Standard installation under a traffic area

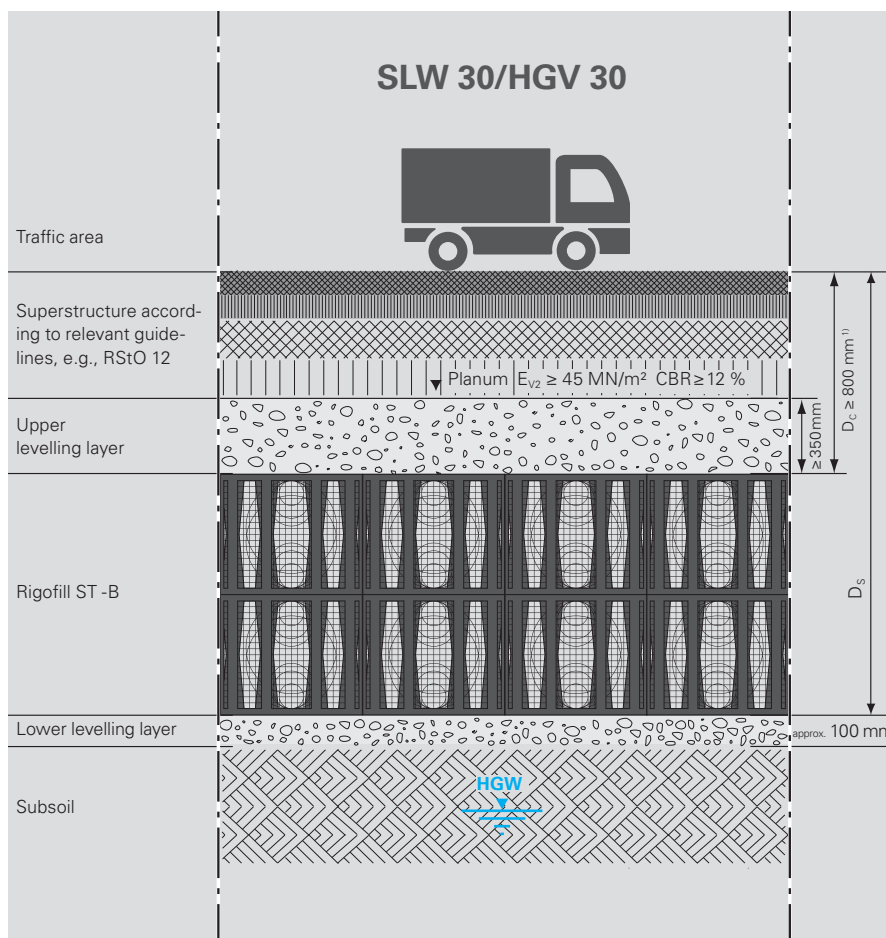

¹⁾ Lower cover on request

Rigofill® ST

The Rigofill ST-B storage/infiltration module is suitable for traffic loads of up to **SLW 30/HGV 30** and therefore also suitable for the construction of systems under parks, greens and car parks. With conventional installation parameters*, depths of cover of D_c 2.5 m and soil depths of D_s 4 m are possible for infiltration systems.

A project-specific stability analysis can be prepared by FRÄNKISCHE.

* HGV 30, specific weight of soil 18 kN/m^3
mean soil temperature max. $23 \text{ }^\circ\text{C}$,
 $\kappa = 0.3$

NB

for HGW over structure soil

Rigofill ST-B systems, which are used as watertight storage systems with impermeable plastic membrane, have been designed for application above the highest groundwater level (HGW).

High installation depths and use in groundwater are possible under corresponding technical conditions after consultation with FRÄNKISCHE. (See pages 10–11)

Please contact us!

Example – Rigofill® ST-B



Rigofill® ST-B

SLW 30/HGV 30

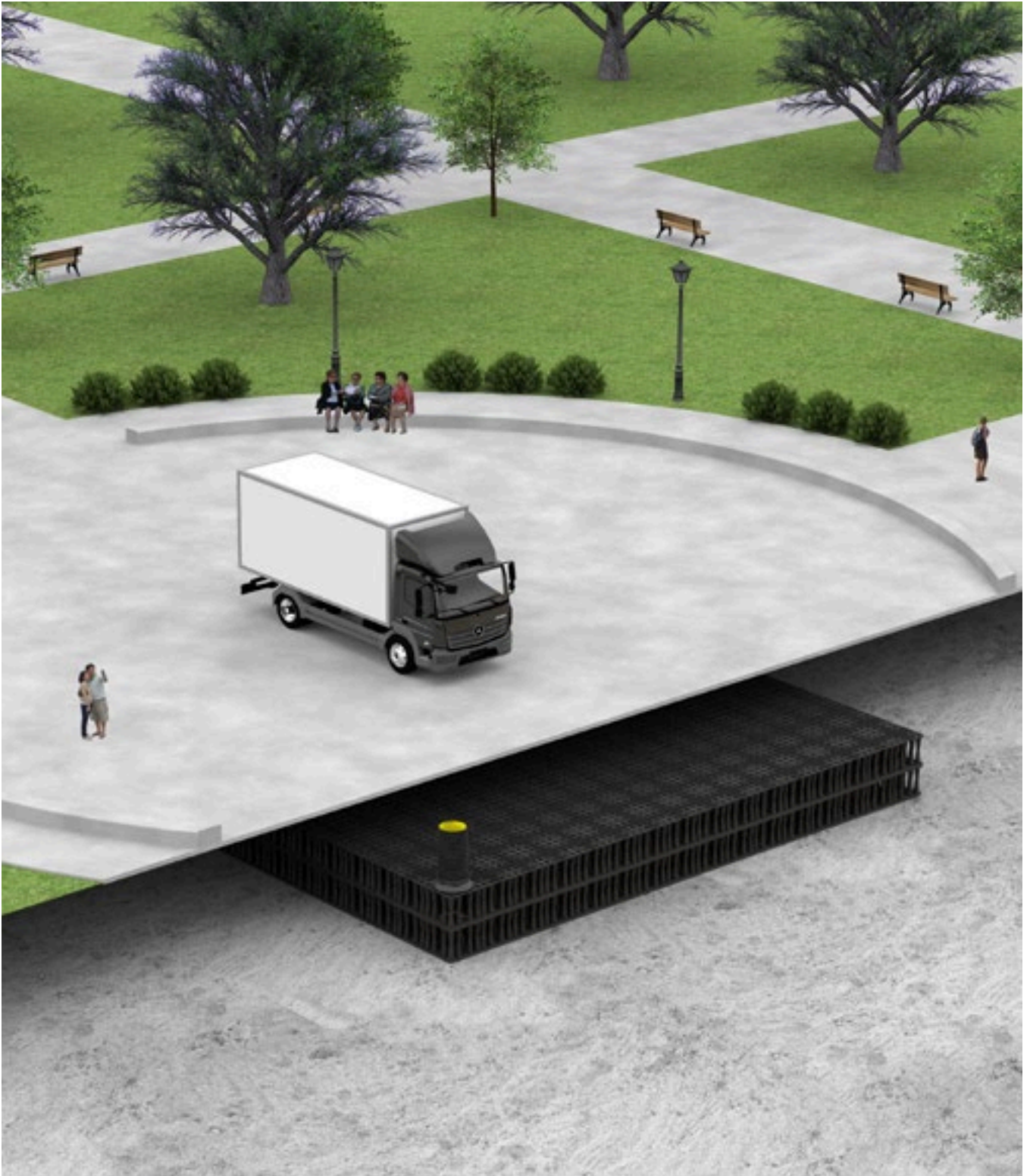

Quadro® Control ST – system shaft

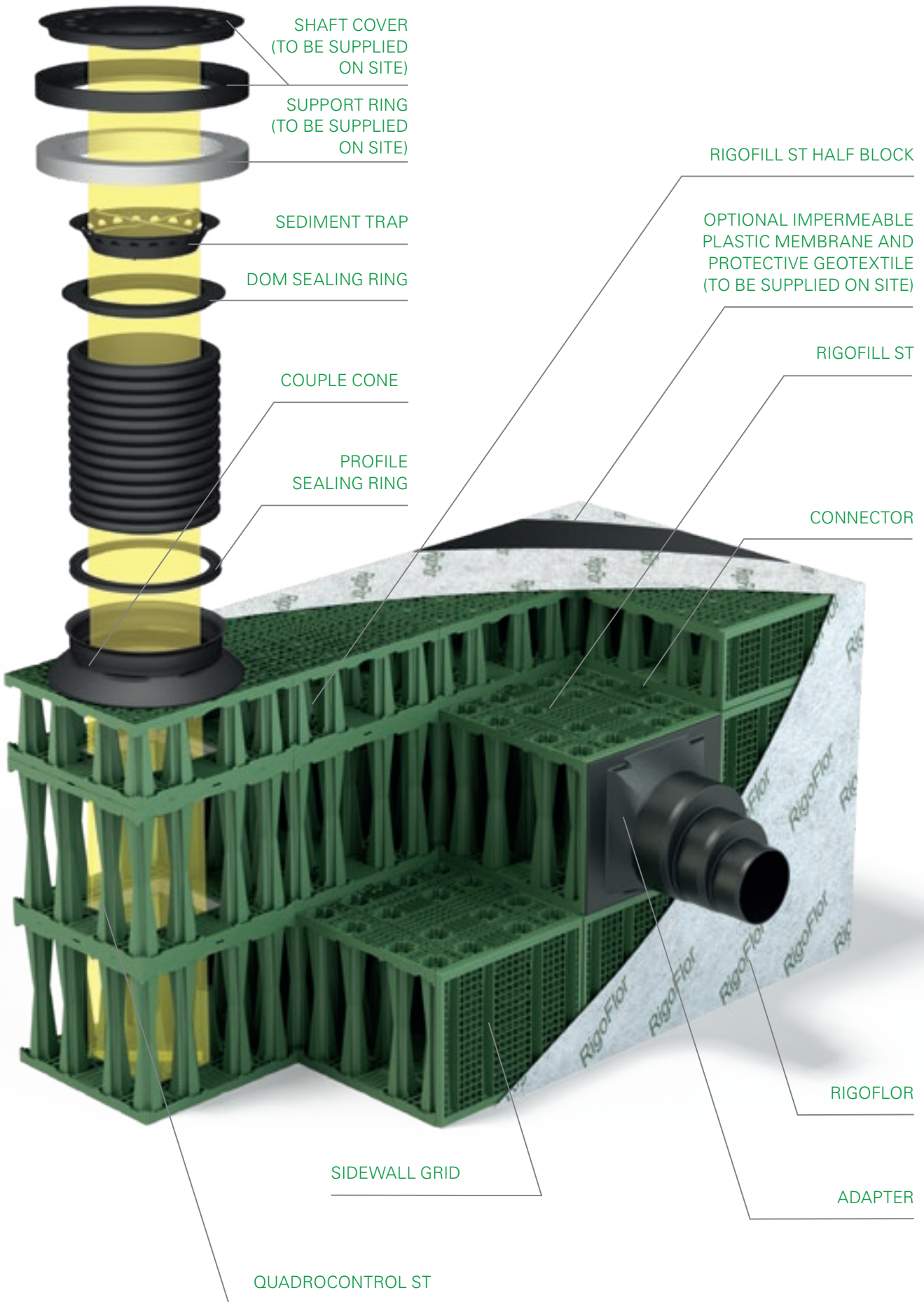

Quadro® Control ST – system shaft



Integrated inspection shafts

QuadroControl ST is a polypropylene inspection shaft which can be integrated in the storage/infiltration system. It is square with a base of 800 x 800 mm and can be used anywhere in the layout. Its height results from the number of layers of the connected storage/infiltration system. The shaft allows comfortable access to the inspection tunnel from above ground. High-performance inspection and flushing equipment can easily be inserted into the inspection tunnel. The shaft is integrated into the storage/infiltration system and grows layer by layer as construction progresses. QuadroControl ST is delivered with all required components and will be assembled on site.

Structure

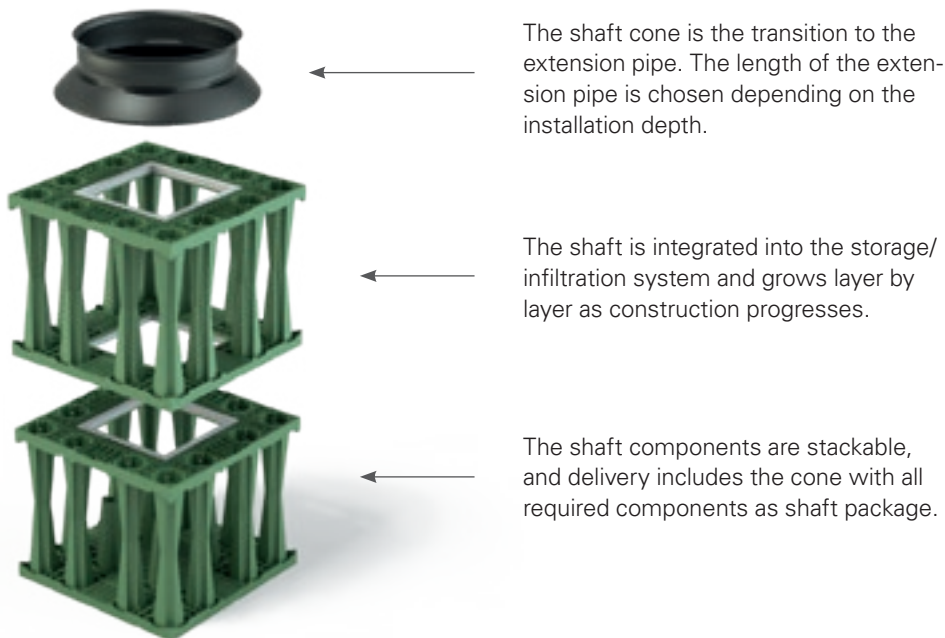

Arrangement of inspection shafts

Number of and position in the system are above all determined by the size of the system, access, pipe connections and design of the outdoor facilities.

In order to ensure that flushing of the complete system is possible, each row should comprise at least one inspection shaft. In addition, the shafts should be positioned such that the shaft covers do not interfere with the design of the outdoor facilities, but can easily be accessed by vehicles for maintenance purposes.

Adjacent shafts should be staggered in the layout.

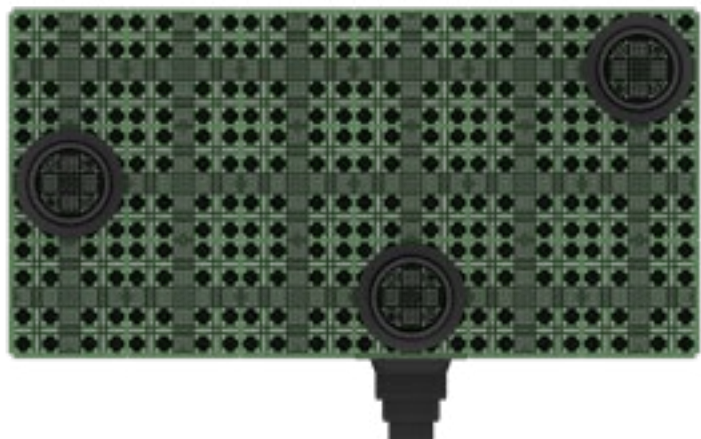

Design-relevant dimensions – Rigofill® ST



Dimensions

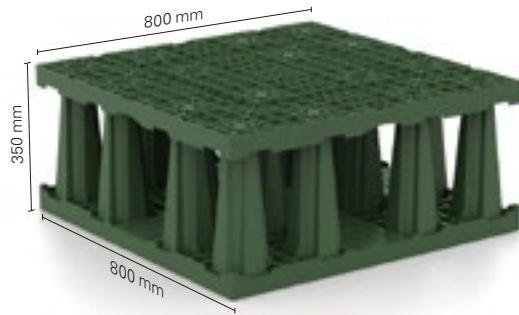

Sidewall grid connection options

Full block connection options

DN/OD 125, 200, 250, 300, 500

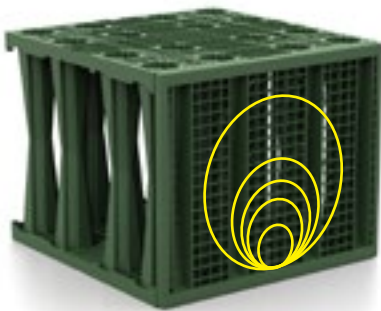

Connections at the top or at the bottom

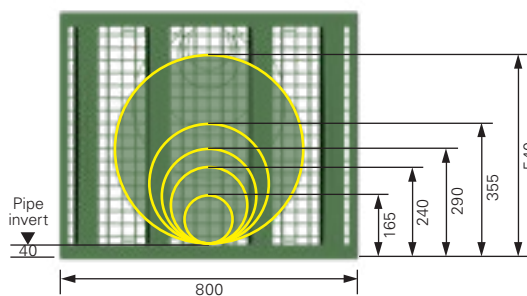

NB

Generally, sidewall grids can also be installed turned by 180°.

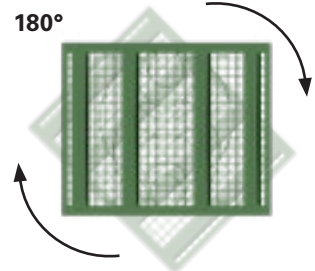

Full block connection options

DN/OD 110, 160, 270, 400



Connections at the top or at the bottom

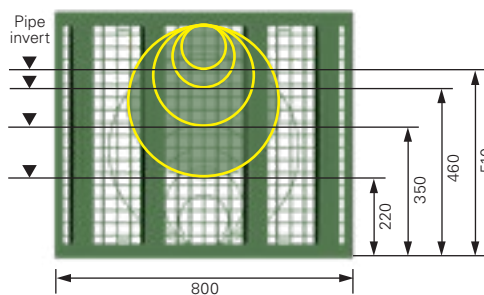

This allows all available nominal diameters to be realised both at the top and the bottom of the module.

Design-relevant dimensions – Rigofill® ST



Sidewall grid connection options

Half block connection options

DN/OD 110, 125, 160, 200, 250, 270

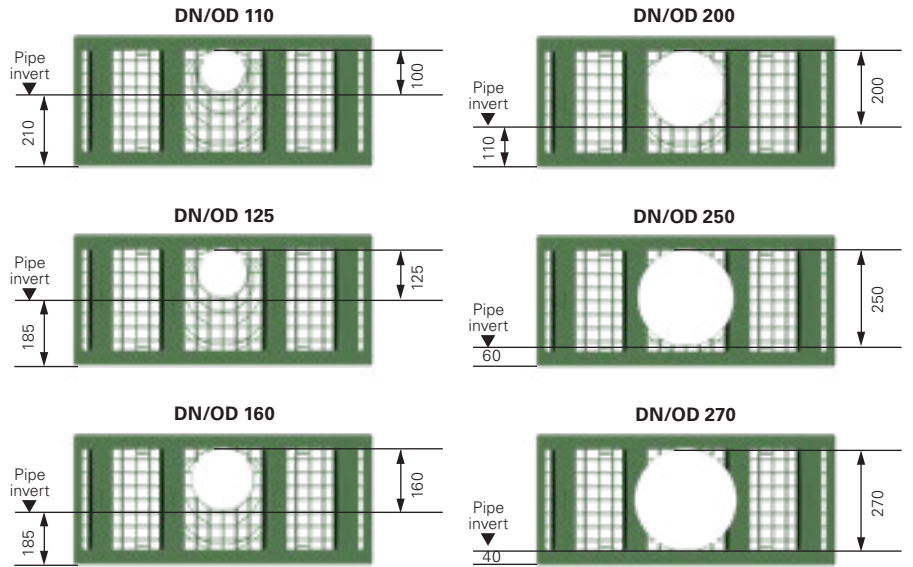
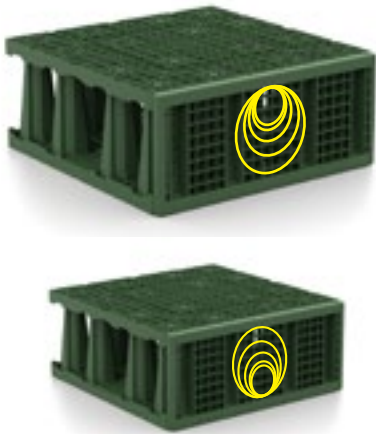

Adapter connection options

Connection options

DN 315, 400, 500

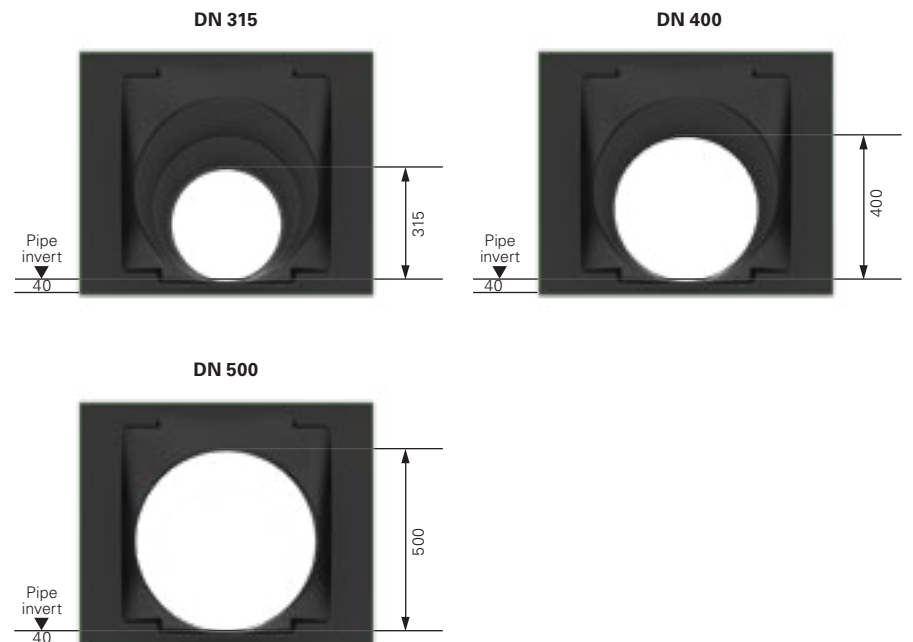

Quadro® Control ST – design-relevant dimensions



Quadro® Control ST dimensions

Connection options **A1**

DN/OD 200 or DN/OD 315 connection possible

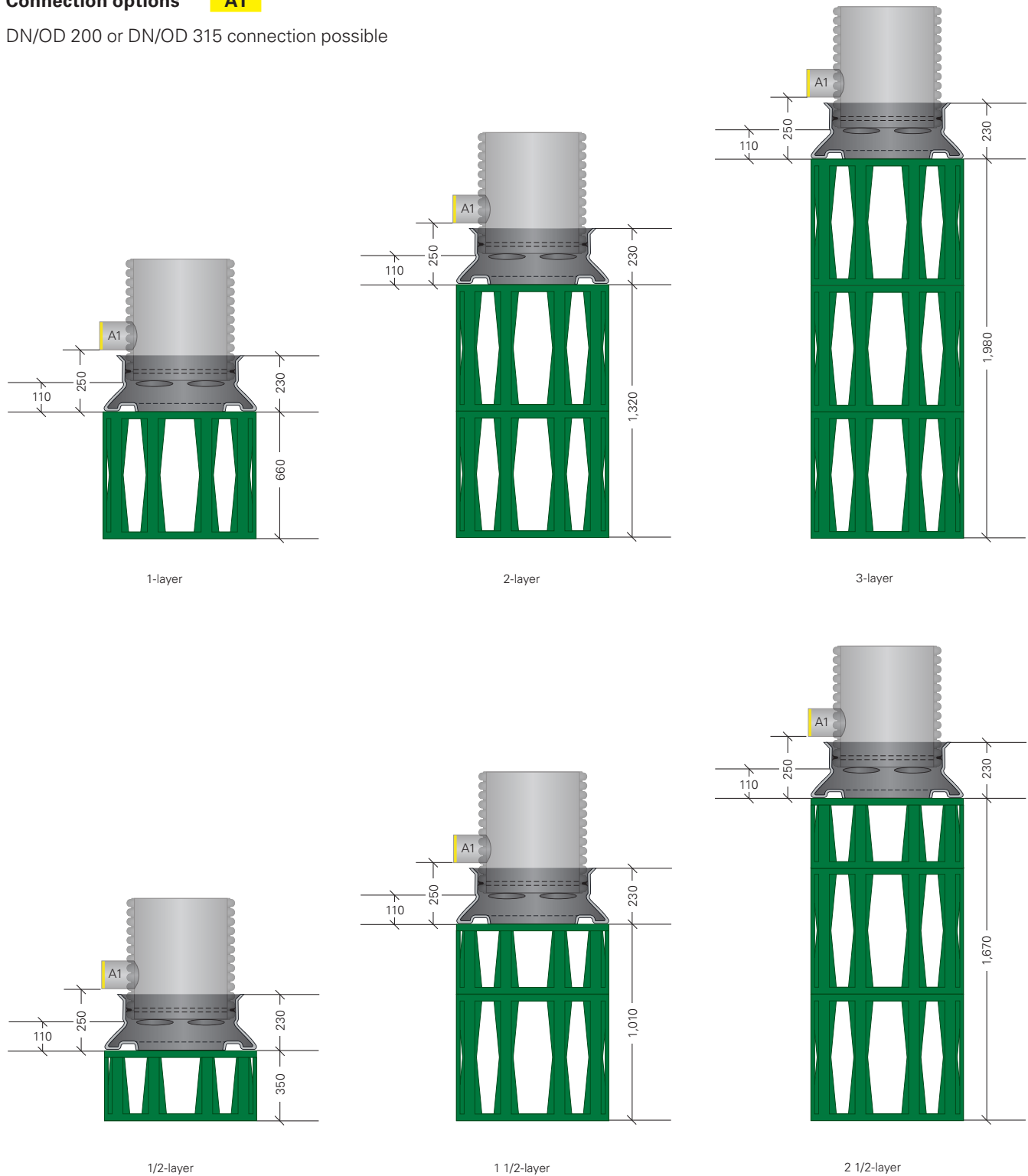



Quadro® Control ST shaft structure



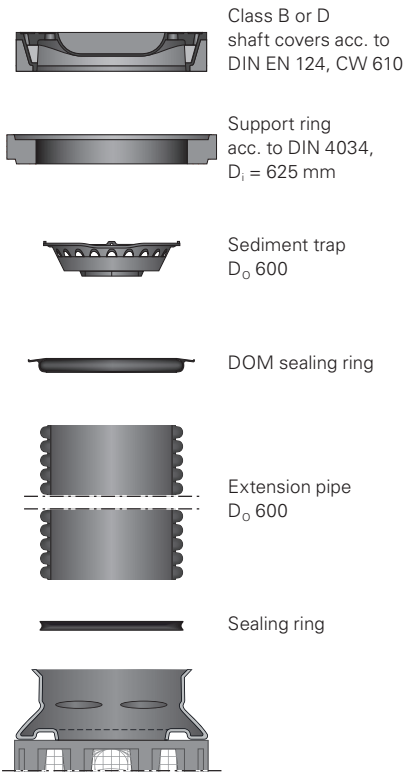



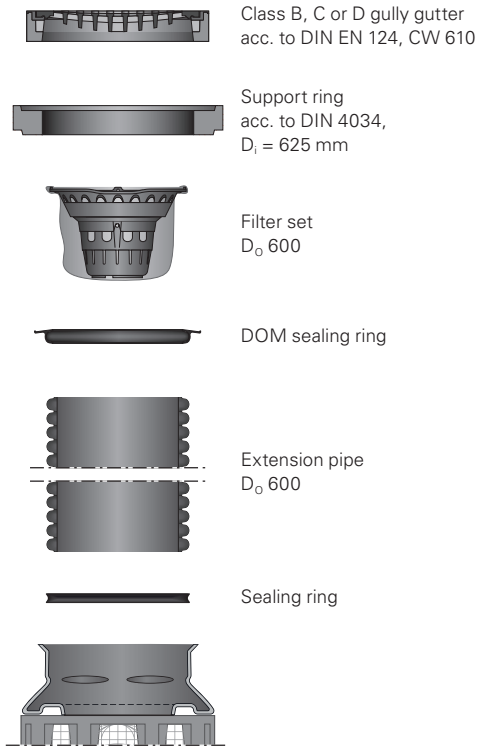

Structure for inspection shaft

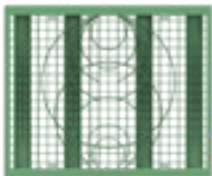

Structure of swale emergency overflow



Rigofill® ST – product overview

	Product	Technical data	Cat. no.		
Full block		Rigofill ST	W x D x H = 800 x 800 x 660 mm 422 l gross volume 406 l storage volume	51594000	
Half block		Rigofill ST half block	W x D x H = 800 x 800 x 350 mm 224 l gross volume 212 l storage volume	51594001	
Sidewall grid full block		Rigofill ST sidewall grid	W x D x H = 800 x 30 x 660 mm Connections: DN 110, 125, 160, 200, 225, 250, 315, 400, 500	51994000	
		Rigofill ST sidewall grid half block	W x D x H = 800 x 30 x 350 mm Connections: DN 110, 125, 160, 200, 225, 250	51994001	
Sidewall grid half block		Rigofill ST sidewall grid, short	W x D x H = 770 x 30 x 660 mm Connections: DN 110, 125, 160, 200, 225, 250, 315, 400, 500	51994010	
		Rigofill ST sidewall grid half block, short	W x D x H = 770 x 30 x 350 mm Connections: DN 110, 125, 160, 200, 225, 250	51994011	
Rigofill ST supporting grid		Rigofill ST supporting grid	for Rigofill ST full block W x D x H = 800 x 37.5 x 800 mm	51994020	
Rigofill ST adapter		Rigofill ST adapter	W x H = 800 x 660 mm Connections: DN 315, 400, 500	51994003	
Single-layer connector		Connector single-layer (suitable for single-layer installations)	Requirement for single-row installation	1 pc(s). per module	51990001
		Requirement for multiple-row installation	2 pc(s). per module		
Multiple-layer connector		Connector multiple-layer (for multiple-layer installations)	Requirement for two-layer installation	1 pc(s). per module	51990004
			Requirement for three-layer installation	1.3 pc(s). per module (factor 1.3)	

	Product	Technical data	Cat. no.	
	Shaft covers acc. to DIN EN 124	Class B or D; CW 610	to be ordered/ supplied on site	
	Gully gutter acc. to DIN EN 124	Class B, C or D; CW 610		
	Support ring acc. to DIN 4034, Part 1	Height: 100 mm		
	Filter set D _o 600	Swale emergency overflow for shafts D _o 600 comprising dirt trap and geotextile filter bag	51991002	
	Geotextile filter bag D _o 600	Replacement filter set D _o 600	51991099	
	Sediment trap D _o 600	Suitable for installation under CW 610 shaft covers	51991095	
	DOM sealing ring	For extension pipe D _o 600; as seal between concrete support ring and extension pipe	51919505	
	Extension pipe without inlet	D _o 600; 1 m length	51550551	
		D _o 600; 2 m length	51550552	
		D _o 600; 3 m length	51550553	
		D _o 600; 6 m length	51550556	
	Extension pipe with inlet KG DN 315	D _o 600; 1 m length	51550531	
		D _o 600; 2 m length	51550532	
		D _o 600; 3 m length	51550533	
1/2-layer		QuadroControl ST 1/2-layer	WxDxH = 800x800x350 mm ¹⁾ incl. couple cone and one profile sealing ring	51504005
		QuadroControl ST 1-layer	WxDxH = 800x800x660 mm ¹⁾ incl. couple cone and one profile sealing ring	51504010
1 1/2-layer		QuadroControl ST 1 1/2-layer	WxDxH = 800x800x1,010 mm ¹⁾ incl. couple cone and one profile sealing ring	51504015
		QuadroControl ST 2-layer	WxDxH = 800x800x1,320 mm ¹⁾ incl. couple cone and one profile sealing ring	51504020
		QuadroControl ST 2 1/2-layer	WxDxH = 800x800x1,670 mm ¹⁾ incl. couple cone and one profile sealing ring	51504025
		QuadroControl ST 3-layer	WxDxH = 800x800x1,980 mm ¹⁾ incl. couple cone and one profile sealing ring	51504030
		QuadroControl ST supporting grid	W x D x H = 800 x 37.5 x 800 mm	51994127

²⁾ Plus 230 mm couple cone total height

Rigofill® ST-B – product overview

	Product	Technical data	Cat. no.		
Full block		Rigofill ST-B	W x D x H = 800 x 800 x 660 mm 422 l gross volume 406 l storage volume	51594200	
Half block		Rigofill ST-B half block	W x D x H = 800 x 800 x 350 mm 224 l gross volume 212 l storage volume	51594201	
Sidewall grid full block		Rigofill ST-B sidewall grid	W x D x H = 800 x 30 x 660 mm Connections: DN 110, 125, 160, 200, 225, 250, 315, 400, 500	51994200	
		Rigofill ST-B sidewall grid half block	W x D x H = 800 x 30 x 350 mm Connections: DN 110, 125, 160, 200, 225, 250	51994201	
Sidewall grid half block		Rigofill ST-B sidewall grid, short	W x D x H = 770 x 30 x 660 mm Connections: DN 110, 125, 160, 200, 225, 250, 315, 400, 500	51994210	
		Rigofill ST-B sidewall grid, short half block	W x D x H = 770 x 30 x 350 mm Connections: DN 110, 125, 160, 200, 225, 250	51994211	
Rigofill ST-B supporting grid		Rigofill ST-B supporting grid	for Rigofill ST-B full block W x D x H = 800 x 37.5 x 800 mm	51994220	
Adapter		Adapter for Rigofill ST-B	W x H = 800 x 660 mm Connections: DN 315, 400, 500	51994203	
Single-layer connector		Connector single-layer (suitable for single-layer installations)	Requirement for single-row installation	1 pc(s). per module	51990001
			Requirement for multiple-row installation	2 pc(s). per module	
Multiple-layer connector		Connector multiple-layer (for multiple-layer installations)	Requirement for two-layer installation	1 pc(s). per module	51990004
			Requirement for three-layer installation	1.3 pc(s). per module (factor 1.3)	



Product	Technical data	Cat. no.
Shaft covers acc. to DIN EN 124	Class B or D; CW 610	to be ordered/ supplied on site
Gully gutter acc. to DIN EN 124	Class B, C or D; CW 610	
Support ring acc. to DIN 4034, Part 1	Height: 100 mm	
Filter set D _o 600	Swale emergency overflow for shafts D _o 600 comprising dirt trap and geotextile filter bag	51991002
Geotextile filter bag D _o 600	Replacement filter set D _o 600	51991099
Sediment trap D _o 600	Suitable for installation under CW 610 shaft covers	51991095
DOM sealing ring	For extension pipe D _o 600; for sealing to concrete support ring	51919505
Extension pipe without inlet	D _o 600; 1 m length	51550551
	D _o 600; 2 m length	51550552
	D _o 600; 3 m length	51550553
	D _o 600; 6 m length	51550556
Extension pipe with inlet KG DN 315	D _o 600; 1 m length	51550531
	D _o 600; 2 m length	51550532
	D _o 600; 3 m length	51550533
QuadroControl ST-B 1/2-layer	WxDxH = 800x800x350 mm ¹⁾ incl. couple cone and one profile sealing ring	51504205
QuadroControl ST-B 1-layer	WxDxH = 800x800x660 mm ¹⁾ incl. couple cone and one profile sealing ring	51504210
QuadroControl ST-B 1 1/2-layer	WxDxH = 800x800x1,010 mm ¹⁾ incl. couple cone and one profile sealing ring	51504215
QuadroControl ST-B 2-layer	WxDxH = 800x800x1,320 mm ¹⁾ incl. couple cone and one profile sealing ring	51504220
QuadroControl ST-B 2 1/2-layer	WxDxH = 800x800x1,670 mm ¹⁾ incl. couple cone and one profile sealing ring	51504225
Supporting grid QuadroControl ST-B	W x D x H = 800 x 37.5 x 800 mm	51994128

1/2-layer

1 1/2-layer

²⁾ Plus 230 mm couple cone total height

Our services

Water · Know-how · Consulting

Any task related to handling stormwater presents individual challenges. Framework conditions of individual projects vary significantly:





- quantity and characteristic of stormwater,
- entry of pollutants from surfaces and the air in the respective area depending on land use,
- geological, hydrogeological conditions,
- aspects of urban development and landscaping

to name but a few considerations which must be made beforehand.

Relevant standards and provisions must be observed when planning and dimensioning storage/ infiltration systems.

In addition to construction companies and design engineers, our consulting services are particularly interesting for builders/project developers who want to sustainably protect their investment using economic and durable solutions.

Further information

- Installation manual   www.fraenkische.com
- Price list 
- Tender documents 
- Installation video 

CAD library

Documents such as CAD catalogues and CAD drawings are available for download under "Stormwater management" on our website. Standard installation situations and detailed drawings are shown as sections and plans, which can be modified by the design engineer to meet specific project needs.

These drawings can then be included in the design documents or added to the tender documents as illustrative detailed drawings.

CAD data  www.fraenkische.com



Contact and Service



www.fraenkische.com/contact-drainage



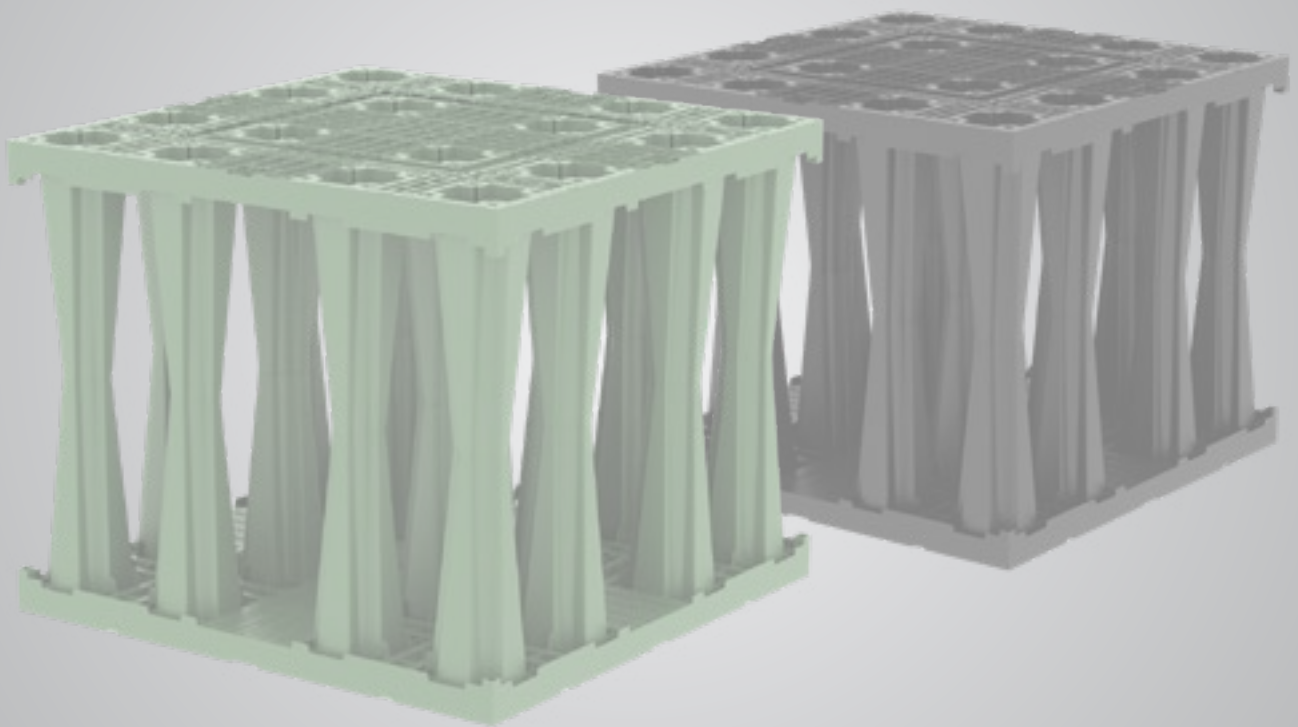

© stock.adobe.com



FRÄNKISCHE

Fränkische Rohrwerke Gebr. Kirchner GmbH & Co. KG | Hellinger Str. 1 | 97486 Königsberg/Germany
Phone +49 9525 88-0 | Fax +49 9525 88-155 | marketing@fraenkische.de | www.fraenkische.com

EN.90015/3.05.23 | Subject to change without notice | Cat. no. 5000-0893-00X | 09/2022 [DE.90013/2]

